

PRODUCT SPECIFICATIONS

Elkay Quartz Classic® 33" x 18-3/4" x 9-1/2", Single Bowl Undermount Sink. Sink is molded with up to 80% natural quartz and high performance acrylic resins that are non-porous providing superior heat, scratch, fade and stain resistance. Naturally sound deadening and Rear Right drain placement.



| | |
|------------------------------|--|
| Installation Type: | Undermount |
| Material: | Quartz |
| Finish: | Bisque (BQ), Black (BK), Dusk Gray (GY), Greige (GR), Greystone (GS), Mocha (MC), Putty (PT), White (WH) |
| Number of Bowls: | 1 |
| Sink Dimensions: | 33" x 18-3/4" x 9-1/2" |
| Bowl 1 Dimensions: | 30-5/16" x 16-7/16" x 9-1/2" |
| Drain Size: | 3-1/2" (89mm) |
| Drain Location: | Rear Right |
| Minimum Cabinet Size: | 36" |
| Mounting Hardware: | Part # 54300408 included |
| Template Included: | Yes |
| Cutout Template #: | 0000001440 |

Template is available for download at [elkay.com](#). CAD software will be required to open the template.

A Century of Tradition and Quality.
For more than 100 years, Elkay has been making innovative products and providing exceptional customer care. We take pride in offering plumbing products that make life easier, inspire change and leave the world a better place.

Product Compliance: CSA B45.5/IAPMO Z124



Sinks are listed by IAPMO® as meeting the applicable requirements of the Uniform Plumbing Code®, International Plumbing Code®, and National Plumbing Code of Canada.

[Clean and Care Manual \(PDF\)](#)
[Installation Instructions \(PDF\) - 1000005238](#)
[Warranty \(PDF\)](#)

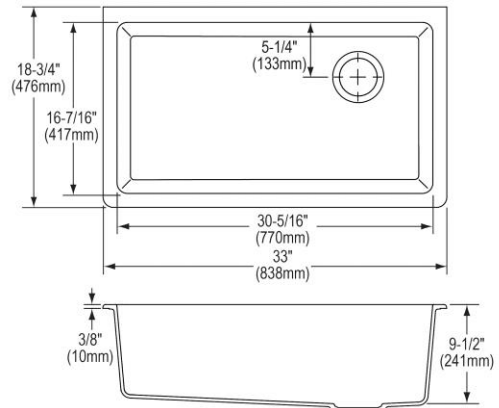





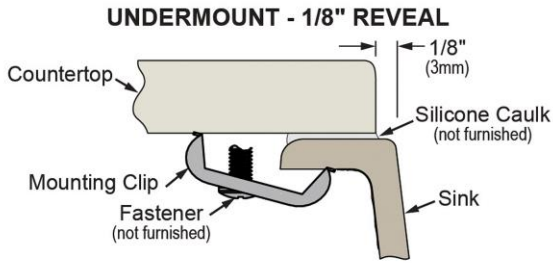

PART: _____ QTY: _____
 PROJECT: _____
 CONTACT: _____
 DATE: _____
 NOTES: _____
 APPROVAL: _____

In keeping with our policy of continuing product improvement, Elkay reserves the right to change product specifications without notice. Please visit [elkay.com](#) for the most current version of Elkay product specification sheets. This specification describes an Elkay product with design, quality, and functional benefits to the user. When making a comparison of other producers' offerings, be certain these features are not overlooked.

Installation Profile:



Designed to affix to the underside of any solid surface countertop.

| Optional Accessories | | |
|------------------------------|--|---|
| LKOBG3016RSS | Elkay Stainless Steel 28-1/4" x 14-5/16" x 1-1/4" Bottom Grid Spec Sheet (PDF) |  |
| LK99 | Elkay Deluxe 3-1/2" Drain Type 304 Stainless Steel Body Strainer Basket Rubber Seal and Tailpiece Spec Sheet (PDF) |  |
| LKQD35 | Elkay Polymer 3-1/2" Disposer Flange with Removable Basket Strainer and Rubber Stopper Spec Sheet (PDF) |  |
| LKQS35 | Elkay Polymer 3-1/2" Drain Fitting with Removable Basket Strainer and Rubber Stopper Spec Sheet (PDF) |  |
| LK6000CR | Elkay Everyday Single Hole Deck Mount Kitchen Faucet with Pull-down Spray Forward Only Lever Handle Chrome Spec Sheet (PDF) |  |
| LKEC2031 | Elkay Explore Single Hole Kitchen Faucet with Pull-down Spray and Forward Only Lever Handle Spec Sheet (PDF) |  |

In keeping with our policy of continuing product improvement, Elkay reserves the right to change product specifications without notice. Please visit elkay.com for the most current version of Elkay product specification sheets. This specification describes an Elkay product with design, quality, and functional benefits to the user. When making a comparison of other producers' offerings, be certain these features are not overlooked.